

LED-PAR83 LEDsplash™ Jr.

USER MANUAL



CHAUVET, 3000 N 29th Ct, Hollywood, FL 33020 U.S.A
(800) 762-1084 – (954) 929-1115
FAX (954) 929-5560
www.chauvetlighting.com

Table of Content

BEFORE YOU BEGIN.....	3
What is included.....	3
Unpacking Instructions.....	3
AC Power.....	3
Safety Instructions.....	3
INTRODUCTION	4
Features.....	4
DMX Channel Summary.....	4
Product Overview.....	5
SETUP	6
Power.....	6
Mounting.....	6
OPERATING INSTRUCTIONS.....	7
Master/Slave & Stand-Alone Mode.....	7
Daisy Chain Connection.....	7
Built-in Program Options.....	7
Manual Control Options.....	8
DMX Control Mode.....	8
Setting the DMX address.....	8
APPENDIX.....	10
DMX Primer.....	10
Fixture Linking.....	10
DMX Channel Values.....	11
Returns Procedure.....	11
Claims.....	11
DMX Dipswitch Quick Reference Chart.....	12
Technical Specifications.....	13
Technical Support.....	13

BEFORE YOU BEGIN

What is included

- 1 x LED-PAR83 LEDsplash™ JR
- 1 x Power cable (1 m) and 1 x Linking cable (1.5 m)
- Warranty Card
- Users Manual

Unpacking Instructions

Immediately upon receiving a product, carefully unpack the carton, check the contents to ensure that all parts are present, and have been received in good condition. Notify the shipper immediately and retain packing material for inspection if any parts appear damaged from shipping or the carton itself shows signs of mishandling. Save the carton and all packing materials. In the event that a fixture must be returned to the factory, it is important that the fixture be returned in the original factory box and packing.

AC Power

To determine the power requirements for a particular product, see the label affixed to the back plate of the product or refer to the product's specifications chart. A product's listed current rating is its average current draw under normal conditions. All fixtures must be powered directly off a switched circuit and cannot be run off a rheostat (variable resistor) or dimmer circuit, even if the rheostat or dimmer channel is used solely for a 0% to 100% switch. Before applying power, check that the source voltage matches the product's requirement. Check the product or device carefully to make sure that if a voltage selection switch exists that it is set to the correct line voltage you will use.

AC Voltage Switch Example



Warning!

If applicable, verify that the power select switch on your unit matches the line voltage applied. All fixtures must be connected to circuits with a suitable Earth Ground.

Safety Instructions



Please read these instructions carefully, which includes important information about the installation, usage and maintenance?



- Please keep this User Guide for future consultation. If you sell the unit to another user, be sure that they also receive this instruction booklet.
- Always make sure that you are connecting to the proper voltage and that the line voltage you are connecting to is not higher than that stated on decal or rear panel of the fixture.
- This product is intended for indoor use only!
- To prevent risk of fire or shock, do not expose fixture to rain or moisture. Make sure there are no flammable materials close to the unit while operating.
- The unit must be installed in a location with adequate ventilation, at least 50cm from adjacent surfaces. Be sure that no ventilation slots are blocked.
- Always disconnect from power source before servicing or replacing lamp or fuse and be sure to replace with same lamp source.
- Secure fixture to fastening device using a safety chain. Never carry the fixture solely by its head. Use its carrying handles.
- Maximum ambient temperature is $T_a: 40^\circ$. Do not operate fixture at temperatures higher than this.
- In the event of serious operating problem, stop using the unit immediately. Never try to repair the unit by yourself. Repairs carried out by unskilled people can lead to damage or malfunction. Please contact the nearest authorized technical assistance center. Always use the same type spare parts.
- Don't connect the device to a dimmer pack.
- Make sure power cord is never crimped or damaged.
- Never disconnect power cord by pulling or tugging on the cord.
- Avoid direct eye exposure to lamp while it is on.

Caution!

There are no user serviceable parts inside the unit. Do not open the housing or attempt any repairs yourself. In the unlikely event your unit may require service, please contact CHAUVET.

INTRODUCTION

Features

CONTROL FEATURES

- 5-channel DMX-512 LED wash light
- Blackout/static/dimmer/strobe
- Static colors and RGB color mixing with or without DMX controller

FEATURES

- Additional power output: max 50 units @ 120V (see manual for details) (115V models only)
- Linkable power with other LEDrain™ and LEDsplash™ units (115V models only)
- Built-in automated programs via master/slave

OPTIONS

- Programmable: Any universal DMX-512 controller

DMX Channel Summary

CHANNEL	INTENSITY CONTROL OF
1	Reserved
2	Blackout/Strobe/Dimmer
3	Red
4	Green
5	Blue

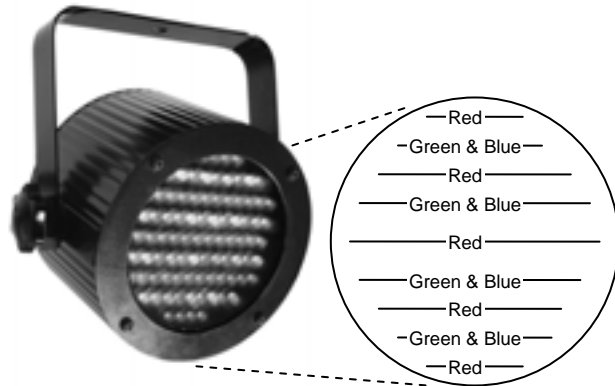

Product Overview

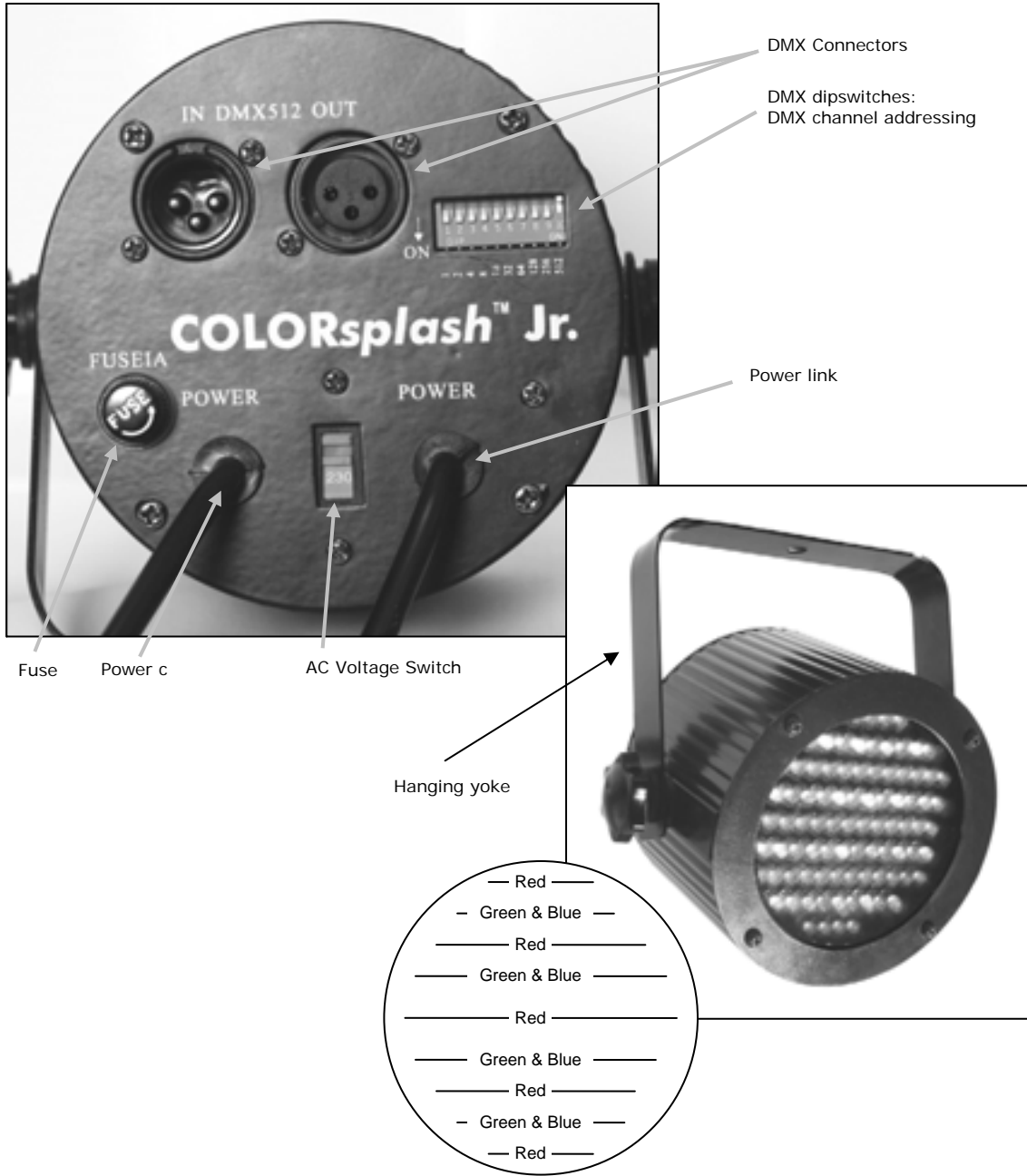

SETUP

Power

Warning! *Verify that the power indicator label on your unit matches the line voltage applied. All fixtures must be connected to circuits with a suitable Earth Ground.*

- To determine the power requirements for a particular fixture, see the label affixed to the back plate of the fixture or refer to the fixture's specifications chart.
- A fixture's listed current rating is its average current draw under normal conditions.
- All fixtures must be powered directly off a switched circuit and cannot be run off a rheostat (variable resistor) or dimmer circuit, even if the rheostat or dimmer channel is used solely for a 0% to 100% switch.
- Before applying power to a fixture, check that the source voltage matches the fixture's requirement.
- All fixtures must be connected to circuits with a suitable Earth Ground.

Power Cable Configuration

CABLE	PIN	INTERNATIONAL
BROWN	Live	L
BLUE	Neutral	N
YELLOW/GREEN	Earth	EG (Ground)

Mounting

Orientation

This fixture can be mounted on a truss using a clamp in any position.

Optional Hanging Clamp



Rigging

The fixture includes a mounting yoke to which 1 rigging clamp can be bolted.

1. Align the clamp screw with the center hole on the yoke and tighten.
2. Verify the structure can hold 10 times the weight of all to-be installed fixtures.
3. Adjust the angle on the yoke arm as necessary.

OPERATING INSTRUCTIONS

The LEDsplash™ Jr. is a DMX-512 controllable, full RGB color mix par can made up of highly efficient and super bright LED's. There are three color groups (Red, Green and Blue) whose intensity can be controlled individually allowing the creation of an unlimited range of colors.

The LEDsplash™ Jr. can operate in Stand-Alone, Master/Slave and via DMX-512 control utilizing 4 channels.

Master/Slave & Stand-Alone Mode

The Master/Slave mode will allow you to link up to as many units you want in a daisy chain fashion. In this mode, the first unit in the daisy chain will automatically command all other units following.

1. Connect all LEDsplash™ Jr. units in a daisy chain fashion as described in the section following.
2. Master Unit: Set dipswitch # 9 to ON and #10 to OFF.
3. Slaves: Set dipswitch # 10 to the ON position and all others to the OFF position.
4. You can also run the fixtures in an automatic stand-alone mode by simply setting all fixtures to run as master units.

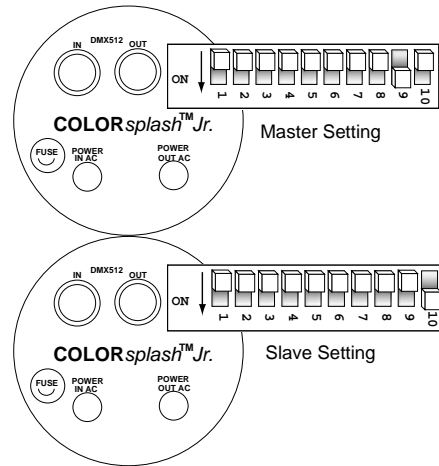

Daisy Chain Connection

1. Connect the (male) 3 pin connector side of the DMX cable to the output (female) 3 pin connector of the first fixture.
2. Connect the end of the cable coming from the first fixture which will have a (female) 3 pin connector to the input connector of the next fixture consisting of a (male) 3 pin connector. Then, proceed to connect from the output as stated above to the input of the following fixture and so on.

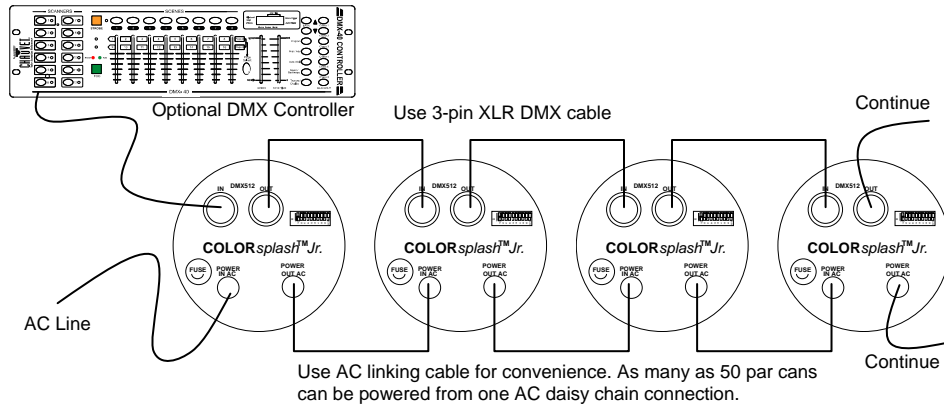

Built-in Program Options

There are 8 Individual programs that can be accessed by turning ON dipswitches 1 through 8 individually.

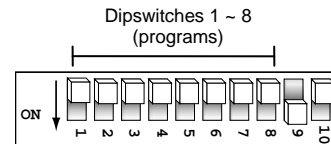

Manual Control Options

With all dipswitches set to the OFF position, dipswitches 1 through 8 will control 3 levels of intensity for red and green LED's and 2 levels of intensity for blue LED's.

This allows you to statically set a color of preference without the use of a controller. By setting different intensities for all 3 led colors you can compose a color of your choice.

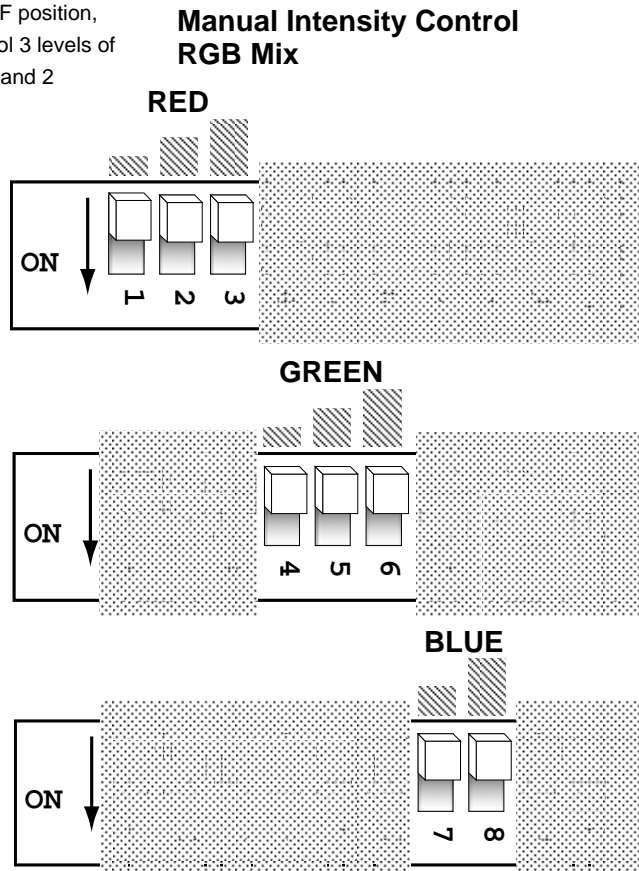

DMX Control Mode

Operating in a DMX Control mode environment gives the user the greatest flexibility when it comes to customizing or creating a show. In this mode you will be able to control each individual trait of the fixture and each fixture independently. The LEDsplash™ Jr. uses 4 channels of control.

1. Enable DMX control by setting dipswitch # 10 to the ON position. Use dipswitches 1 through 9 to address each fixture accordingly.

Setting the DMX address

This DMX mode enables the use of a universal DMX controller device. Each fixture requires a "start address" from 1 to 511. A fixture requiring one or more channels for control begins to read the data on the channel indicated by the start address. For example, a fixture that occupies or uses 7 channels of DMX and was addressed to start on DMX channel 100, would read data from channels: 100, 101, 102, 103, 104, 105 and 106. Choose start addresses so that the channels used do not overlap and notate the start address selected for future reference.

If this is your first time addressing a fixture using the DMX-512 control protocol than I suggest jumping to the Appendix Section and read the heading "DMX Primer". It contains very useful information that will help you understand its use.

Set the start address using the group of DIP switches located usually on bottom of the fixture. Each dip switch has an associated value. Adding the value of each switch in the ON position will provide the start address. Determining which switches to toggle ON given a specific start address can be accomplished in the following manner. By subtracting the largest switch value possible from the selected start address until zero is achieved.

EXAMPLE STARTING ADDRESS																							
<p>Address 10</p> <p>Pin # 4 = 8 Pin # 2 = 2 Total = 10</p>																							
<p>Address 24</p> <p>Pin # 5 = 16 Pin # 4 = 8 Total = 24</p>																							
<p>Resolving address using simple math.</p> <p>Address 233</p>	<p>233 – (128) = 105, Turn ON Dip # 8 105 – (64) = 41, Turn ON Dip # 7 41 – (32) = 9, Turn ON Dip # 6 9 – (8) = 1, Turn ON Dip # 4 1 – (1) = 0, Turn ON Dip # 1</p> <p>You will most likely use the first available number which maybe number 1. This number was selected for example purposes.</p> <table border="1" style="margin-left: auto; margin-right: auto;"> <thead> <tr> <th>DIP SWITCH</th> <th>(DMX VALUE)</th> </tr> </thead> <tbody> <tr><td>1</td><td>1</td></tr> <tr><td>2</td><td>2</td></tr> <tr><td>3</td><td>4</td></tr> <tr><td>4</td><td>8</td></tr> <tr><td>5</td><td>16</td></tr> <tr><td>6</td><td>32</td></tr> <tr><td>7</td><td>64</td></tr> <tr><td>8</td><td>128</td></tr> <tr><td>9</td><td>256</td></tr> <tr><td>10</td><td></td></tr> </tbody> </table>	DIP SWITCH	(DMX VALUE)	1	1	2	2	3	4	4	8	5	16	6	32	7	64	8	128	9	256	10	
DIP SWITCH	(DMX VALUE)																						
1	1																						
2	2																						
3	4																						
4	8																						
5	16																						
6	32																						
7	64																						
8	128																						
9	256																						
10																							

APPENDIX

DMX Primer

There are 512 channels in a DMX-512 connection. Channels may be assigned in any manner. A fixture capable of receiving DMX-512 will require one or a number of sequential channels. The user must assign a starting address on the fixture that indicates the first channel reserved in the controller. There are many different types of DMX controllable fixtures and they all may vary in the total number of channels required. Choosing a start address should be planned in advance. Channels should never overlap. If they do, this will result in erratic operation of the fixtures whose starting address is set incorrectly. You can however, control multiple fixtures of the same type using the same starting address as long as the intended result is that of unison movement or operation. In other words, the fixtures will be slaved together and all respond exactly the same.

DMX fixtures are designed to receive data through a serial Daisy Chain. A Daisy Chain connection is where the DATA OUT of one fixture connects to the DATA IN of the next fixture. The order in which the fixtures are connected is not important and has no effect on how a controller communicates to each fixture. Use an order that provides for the easiest and most direct cabling. Connect fixtures using shielded two conductor twisted pair cable with three pin XLR male to female connectors. The shield connection is pin 1, while pin 2 is Data Negative (S-) and pin 3 is Data positive (S+). CHAUVET carries 3-pin XLR DMX compliant cables, DMX-10 (33'), DMX-4.5 (15') and DMX-1.5 (5')

Fixture Linking

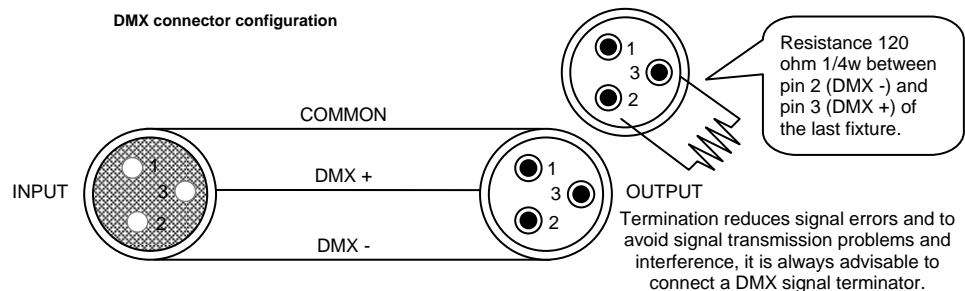

Note!

If you use a controller with a 5 pin DMX output connector, you will need to use a 5 pin to 3 pin adapter. CHAUVET Model No: DMX5M. The chart below details a proper cable conversion:

3 PIN TO 5 PIN CONVERSION CHART

Conductor	3 Pin Female (output)	5 Pin Male (Input)
Ground/Shield	Pin 1	Pin 1
Data (-) signal	Pin 2	Pin 2
Data (+) signal	Pin 3	Pin 3
Do not use		Do not use
Do not use		Do not use

DMX Channel Values

DEFAULT	VALUE	FUNCTION
1	000 ⇔ 255	Reserved
2	000 ⇔ 001 002 ⇔ 127 128 ⇔ 255	Shutter/Strobe/Dimmer Blackout Strobe: Slow > Fast Intensity: 0% > 100%
3	000 ⇔ 255	Red 0 > 100%
4	000 ⇔ 255	Green 0 > 100%
5	000 ⇔ 255	Blue 0 > 100%

Returns Procedure

Returned merchandise must be sent prepaid and in the original packing, call tags will not be issued. Package must be clearly labeled with a Return Merchandise Authorization Number (RMA #). Products returned without an RMA # will be refused. Call CHAUVET and request RMA # prior to shipping the fixture. Be prepared to provide the model number, serial number and a brief description of the cause for the return. Be sure to properly pack fixture, any shipping damage resulting from inadequate packaging is the customer's responsibility. CHAUVET reserves the right to use its own discretion to repair or replace product(s). As a suggestion, proper UPS packing or double-boxing is always a safe method to use.

Claims

Damage incurred in shipping is the responsibility of the shipper; therefore the damage must be reported to the carrier upon receipt of merchandise. It is the customer's responsibility to notify and submit claims with the shipper in the event that a fixture is damaged due to shipping. Any other claim for items such as missing component/part, damage not related to shipping, and concealed damage, must be made within seven (7) days of receiving merchandise.

DMX Dipswitch Quick Reference Chart

DMX Address Quick Reference Chart

DMX DIP SWITCH SET 0=OFF 1=ON X=OFF or ON					Dip Switch Position																			
					#9	0	0	0	0	0	0	0	0	1	1	1	1	1	1	1	1			
#1	#2	#3	#4	#5	#8	0	0	0	0	1	1	1	1	0	0	0	0	1	1	1	1			
					#7	0	0	1	1	0	0	1	1	0	0	1	1	0	0	1	1			
					#6	0	1	0	1	0	1	0	1	0	1	0	1	0	1	0	1			
0	0	0	0	0						32	64	96	128	160	192	224	256	288	320	352	384	416	448	480
1	0	0	0	0		1	33	65	97	129	161	193	225	257	289	321	353	385	417	449	481			
0	1	0	0	0		2	34	66	98	130	162	194	226	258	290	322	354	386	418	450	482			
1	1	0	0	0		3	35	67	99	131	163	195	227	259	291	323	355	387	419	451	483			
0	0	1	0	0		4	36	68	100	132	164	196	228	260	292	324	356	388	420	452	484			
1	0	1	0	0		5	37	69	101	133	165	197	229	261	293	325	357	389	421	453	485			
0	1	1	0	0		6	38	70	102	134	166	198	230	262	294	326	358	390	422	454	486			
1	1	1	0	0		7	39	71	103	135	167	199	231	263	295	327	359	391	423	455	487			
0	0	0	1	0		8	40	72	104	136	168	200	232	264	296	328	360	392	424	456	488			
1	0	0	1	0		9	41	73	105	137	169	201	233	265	297	329	361	393	425	457	489			
0	1	0	1	0		10	42	74	106	138	170	202	234	266	298	330	362	394	426	458	490			
1	1	0	1	0		11	43	75	107	139	171	203	235	267	299	331	363	395	427	459	491			
0	0	1	1	0		12	44	76	108	140	172	204	236	268	300	332	364	396	428	460	492			
1	0	1	1	0		13	45	77	109	141	173	205	237	269	301	333	365	397	429	461	493			
0	1	1	1	0		14	46	78	110	142	174	206	238	270	302	334	366	398	430	462	494			
1	1	1	1	0		15	47	79	111	143	175	207	239	271	303	335	367	399	431	463	495			
0	0	0	0	1		16	48	80	112	144	176	208	240	272	304	336	368	400	432	464	496			
1	0	0	0	1		17	49	81	113	145	177	209	241	273	305	337	369	401	433	465	497			
0	1	0	0	1		18	50	82	114	146	178	210	242	274	306	338	370	402	434	466	498			
1	1	0	0	1		19	51	83	115	147	179	211	243	275	307	339	371	403	435	467	499			
0	0	1	0	1		20	52	84	116	148	180	212	244	276	308	340	372	404	436	468	500			
1	0	1	0	1		21	53	85	117	149	181	213	245	277	309	341	373	405	437	469	501			
0	1	1	0	1		22	54	86	118	150	182	214	246	278	310	342	374	406	438	470	502			
1	1	1	0	1		23	55	87	119	151	183	215	247	279	311	343	375	407	439	471	503			
0	0	0	1	1		24	56	88	120	152	184	216	248	280	312	344	376	408	440	472	504			
1	0	0	1	1		25	57	89	121	153	185	217	249	281	313	345	377	409	441	473	505			
0	1	0	1	1		26	58	90	122	154	186	218	250	282	314	346	378	410	442	474	506			
1	1	0	1	1		27	59	91	123	155	187	219	251	283	315	347	379	411	443	475	507			
0	0	1	1	1		28	60	92	124	156	188	220	252	284	316	348	380	412	444	476	508			
1	0	1	1	1		29	61	93	125	157	189	221	253	285	317	349	381	413	445	477	509			
0	1	1	1	1		30	62	94	126	158	190	222	254	286	318	350	382	414	446	478	510			
1	1	1	1	1		31	63	95	127	159	191	223	255	287	319	351	383	415	447	479	511			

Dip Switch Position

DMX Address

Technical Specifications

WEIGHT & DIMENSIONS

Length..... 4.92 in (125 mm)
Width 4.92 in (125 mm)
Height 7.87 in (200 mm)
Weight 2.43 lbs (1.1 kg)

POWER

Switch-selectable power setting 115V 60 Hz or 230V 50 Hz
AC input..... Power cord attached
European version 240V 50 Hz
Power output 50 units max

FUSE

Main..... 20mm Glass 1A Fast Blow

LIGHT SOURCE

LED..... 86 (44 red, 21 green, 21 blue) LEDs 100,000hrs

PHOTO OPTIC

Luminance at 1 meter.....(538 lux)
Beam Angle 17°
Field Angle..... 52°

CONTROL & PROGRAMMING

Data input locking 3-pin XLR male socket
Data output locking 3-pin XLR female socket
Data pin configuration pin 1 shield, pin 2 (-), pin 3 (+)
Protocols..... DMX-512 USITT
DMX Channels5

ORDERING INFORMATION

LEDsplash™ Jr..... LED-PAR83

Technical Support

Address: Service Dept.
3000 N 29th Ct, Hollywood, FL 33020 (U.S.A.)
Support (Email): tech@chauvetlighting.com
Telephone: (954) 929-1115 - (Press 4)
Fax: (954) 929-5560 - (Attention: Service)
Website: <http://www.chauvetlighting.com>